

SIGMA**ELECTRONIC FLASH
EF-530 DG ST NA-iTTL**

使用説明書	ISTRUZIONI PER L'USO
INSTRUCTIONS	BRUGSANVISNING
BEDIENUNGSANLEITUNG	用戶手冊
MODE D'EMPLOI	사용자 설명서
GEBRUIKSAANWIJZING	РУКОВОДСТВО ПО ЭКСПЛУАТАЦИИ
INSTRUCCIONES	

SIGMA CORPORATION

2-4-16 Kuriki, Asao-ku, Kawasaki-shi, Kanagawa 215-8530 Japan

Phone : 044 - 989 - 7430 Fax : 044 - 989 - 7451

株式会社シグマ

本社 〒215-8530 神奈川県川崎市麻生区栗木 2丁目 4番 16号

☎(044) 989-7430(代) FAX: (044) 989-7451

(カスタマーサービス直通) ☎(044) 989-7436

工場 〒969-3395 福島県耶麻郡磐梯町大字大谷字日知坂 6594

☎0242(73)2771(代)

札幌営業所 〒007-0865 札幌市東区伏古 5条 4丁目 1番 9号 伏古ビル 2F

☎011(786)3710

大阪営業所 〒541-0059 大阪市中央区博労町 1-7-2 堺筋トラストビル 8F

☎06(6271)1548

福岡営業所 〒812-0013 福岡市博多区博多駅東 1-11-15 博多駅東口ビル 6F

☎092(475)5635

インターネットホームページアドレス <http://www.sigma-photo.co.jp>

(1)

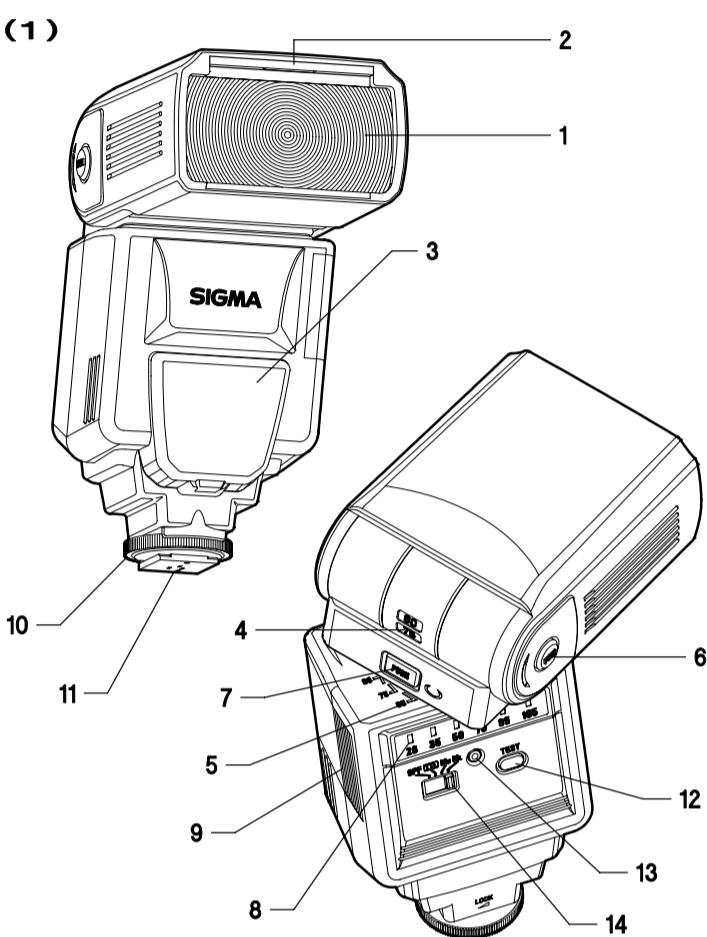

(2)

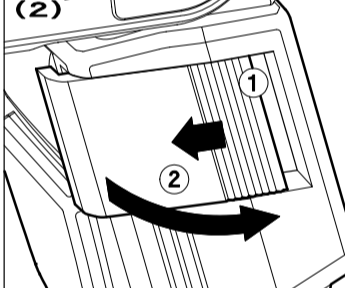

(3)

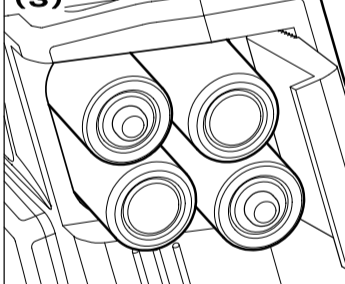

(4)

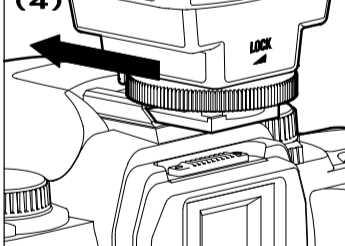

(5)

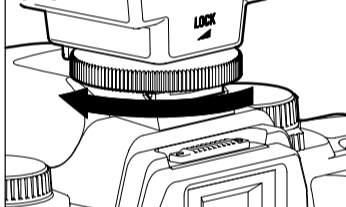

(6)

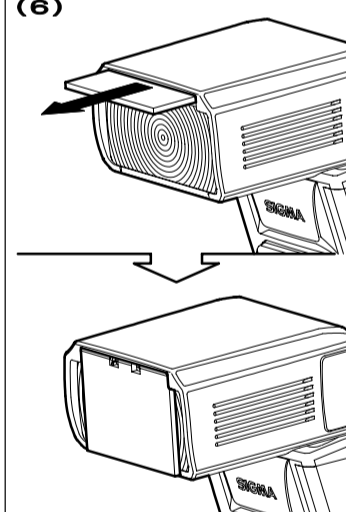

(7)

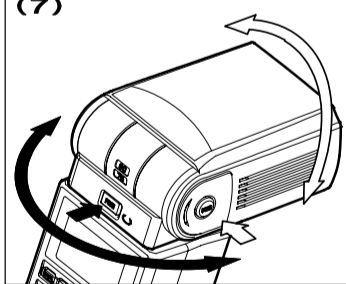

《表1》《chart.1》《Tabelle 1》《Tableau 1》《tabel 1》《Tabla 1》

m
ft

	17mm	24mm	28mm	35mm	50mm	70mm	105mm
1.4	1.3-14.3	1.8-20.0	1.9-20.7	2.0-22.1	2.6-28.6	2.9-32.1	3.4-37.9
	4.3-46.9	5.9-65.6	6.2-67.9	6.6-72.5	8.5-93.8	9.5-105.3	11.2-124.3
2.0	0.9-10.0	1.3-14.0	1.3-14.5	1.4-15.5	1.8-20.0	2.0-22.5	2.4-26.5
	3.0-32.8	4.3-45.9	4.3-47.6	4.6-50.9	5.9-65.6	6.6-73.8	7.9-86.9
2.8	0.7-7.1	0.9-10.0	0.9-10.4	1.0-11.1	1.3-14.3	1.5-16.1	1.7-18.9
	2.3-23.3	3.0-32.8	3.0-34.1	3.3-36.4	4.3-46.9	4.9-52.8	5.6-62.0
4.0	0.7-5.0	0.7-7.0	0.7-7.3	0.7-7.8	0.9-10.0	1.0-11.3	1.2-13.3
	2.3-16.4	2.3-23.0	2.3-24.0	2.3-25.6	3.0-32.8	3.3-37.1	3.9-43.6
5.6	0.7-3.6	0.7-5.0	0.7-5.2	0.7-5.5	0.7-7.1	0.7-8.0	0.9-9.5
	2.3-11.8	2.3-16.4	2.3-17.1	2.3-18.0	2.3-23.3	2.3-26.2	3.0-31.2
8.0	0.7-2.5	0.7-3.5	0.7-3.6	0.7-3.9	0.7-5.0	0.7-5.6	0.7-6.6
	2.3-8.2	2.3-11.5	2.3-11.8	2.3-12.8	2.3-16.4	2.3-18.4	2.3-21.7
11.0	0.7-1.8	0.7-2.5	0.7-2.6	0.7-2.8	0.7-3.6	0.7-4.1	0.7-4.8
	2.3-5.9	2.3-8.2	2.3-8.5	2.3-9.2	2.3-11.8	2.3-13.5	2.3-15.7
16.0	0.7-1.3	0.7-1.8	0.7-1.8	0.7-1.9	0.7-2.5	0.7-2.8	0.7-3.3
	2.3-4.3	2.3-5.9	2.3-5.9	2.3-6.2	2.3-8.2	2.3-9.2	2.3-10.8
22.0	0.7-0.9	0.7-1.3	0.7-1.3	0.7-1.4	0.7-1.8	0.7-2.0	0.7-2.4
	2.3-3.0	2.3-4.3	2.3-4.3	2.3-4.6	2.3-5.9	2.3-6.6	2.3-7.9
32.0		0.7-0.9	0.7-0.9	0.7-1.0	0.7-1.3	0.7-1.4	0.7-1.7
		2.3-3.0	2.3-3.0	2.3-3.3	2.3-4.3	2.3-4.6	2.3-5.6

《表2》《chart.2》《Tabelle 2》《Tableau 2》《tabel 2》《Tabla 2》



	17mm	24mm	28mm	35mm	50mm	70mm	105mm
MH	20.0	28.0	29.0	31.0	40.0	45.0	53.0
ML	5.0	7.0	7.3	7.8	10.0	11.3	13.3

《表3》《chart.3》《Tabelle 3》《Tableau 3》《tabel 3》《Tabla 3》





ISO25	ISO50	ISO200	ISO400	ISO800	ISO1600	ISO3200
20.0	28.0	29.0	31.0	40.0	45.0	53.0

ENGLISH







Thank you very much for purchasing the Sigma EF-530 ST NA-iTTL Electronic Flash. This product is specifically developed for the Nikon series SLR cameras. Depending on the camera model, functions and operation may vary. Please read this instruction booklet carefully. To add to your enjoyment of photography, the flash has a variety of features. To make the most of all these features, and to get the maximum performance and enjoyment from your flash, please read this instruction booklet, together with your camera's instruction manual, before using the flash, and also keep it handy for your future reference.

PRECAUTIONS  Symbol denotes the important points, where warning and caution are required.
 Symbol contains information regarding the actions that must be avoided.

Warning !!
 Using the product disregarding this warning sign might cause serious injury or other dangerous results.

-  This flash contains high voltage circuits. To avoid electric shock or burns, do not attempt to disassemble the flash. If the outside shell of the unit is broken or cracked, do not touch the mechanism inside.
-  Do not fire the flash close to eyes. Otherwise the bright light could damage the eyes. Keep at least 1m/3feet distance between face and the flash unit, when taking a picture with flash.
-  Do not touch the synchro terminal of your camera when the flash is attached to hot shoe.
-  High voltage circuitry could cause electric shock.
-  Never use your camera in an environment where flammable, burnable, gas, liquids or chemicals, etc. exist. Otherwise, it might cause fire or explosion.

Caution!!
 Using the product disregarding this caution sign might cause injury or damage.

-  Do not use this flash unit on any camera other than the Nikon series cameras; otherwise the flash may damage the circuitry of these cameras.
-  This flash unit is not waterproof. When using the flash and camera in the rain or snow or near water, keep it from getting wet. It is often impractical to repair internal electrical components damaged by water.
-  Never subject the flash and camera to shock, dust, high temperature or humidity. These factors might cause fire or malfunctioning of your equipment.
-  When the flash is subjected to sudden temperature change, as when the flash unit is brought from a cold exterior to warm interior, condensation might form inside. In such a case, place your equipment in a sealed plastic bag before such a change, and do not use the flash unit, until it reaches room temperature.
-  Do not store your flash in a drawer or cupboard etc., containing naphthalene, camphor or other insecticides. These chemicals will have negative effects on the flash unit.
-  Do not use a thinner, Benzene or other cleaning agents to remove dirt or finger prints from the component. Clean with a soft, moistened cloth.
-  For extended storage, choose a cool dry place, preferably with good ventilation. It is recommended that the flash be charged and fired several times a month, to maintain proper capacitor functioning.

DESCRIPTION OF THE PARTS (fig.1)

- 1.Flash Head 2.Built-in Wide Panel 3.AF Auxiliary Light 4.Bounce Angle; Up and Down 5.Bounce Angle; Right and Left 6.Bounce Lock and Release Button; Up and Down 7.Swivel Lock and Release Button; Right and Left 8.flash coverage angle indicator 9.Battery Cover 10.Shoe Ring 11.Shoe 12.TEST Button 13.Ready Light 14.Power Switch

ABOUT THE BATTERY

This flash unit uses four "AA" type Alkaline dry cell batteries or Ni-Cad, Ni-MH, rechargeable batteries. Manganese batteries can also be used but as they have a shorter life than Alkaline batteries, we do not recommend using them. Please replace batteries if it takes more than 30seconds to light the Ready Lamp.

- To assure proper electrical contact, clean the battery terminals before installing the batteries
- NiCad batteries do not have standardized contacts. If you use NiCad batteries, please confirm that the battery contacts touch the battery compartment properly.
- To prevent battery explosion, leakage or overheating, use four new AA batteries of the same type and brand. Do not mix the type or new and used batteries.
- Do not disassemble or short-circuit batteries, or expose them fire or water; they may explode. Also, do not recharge the batteries other than Ni-Cd rechargeable batteries.
- When the flash will not be used for an extended period of time, remove the batteries from the flash, to avoid the possibility of damage from leakage.
- Battery performance decreases at low temperatures. Keep batteries insulated when using the flash in cold weather.
- As with any flash, it is recommended you carry spare batteries when on a long trip, or when photographing outdoors in cold weather.

BATTERY LOADING

1. Be sure to set the Power Switch to the off position then slide, the battery cover in the direction of the arrow to open (fig.2).
2. Insert four AA sized batteries into the battery chamber. Be sure the + and - ends of the batteries are aligned according to the diagram in the chamber (fig.3).
3. Close the cover.
4. Slide the Power Switch to the ON position. After few seconds, the Ready Lamp will light, indicating that the flash unit can be fired.
5. Please press the "Test Button" to be sure that the flash is working properly.

■ If the battery power is not sufficient, or if there is an electronic information error, the flash coverage angle indicator will blink to indicate the condition.

ATTACHING AND REMOVING THE FLASH TO AND FROM THE CAMERA

Be sure turn off the Power Switch. Then insert the Shoe Base into the hot shoe on the camera and turn the Shoe Locking Ring until it is tight (fig.4)(fig.5).

- When you attach or remove the flash, grasp the bottom of the flash to prevent damage to the shoe foot and camera's hot shoe.
- If the camera's built-in flash is set in up position, please close it before you attach the flash unit.
- To remove the flash, rotate the shoe-locking ring in the opposite direction of ◀LOCK mark, until it stops.

TTL AUTO FLASH

In the TTL AUTO Mode, the camera will control the amount of flash lighting to get the appropriate exposure for the subject.

Depending on the combination of the camera, lens, exposure mode and metering mode, the TTL system may change. Please refer to Chart.

■ When you use Digital SLR cameras, functions will vary depending on the lens type and combinations of exposure modes, same as F5 and F100 group. (However, all TTL exposure functions will be the D-TTL (i-TTL) system).

Camera	Lens Type	Exp. Mode	Metering	TTL System	Note
F5	D Type	All Modes	All Modes	3-D Multi-Sensor BL	Can switch to TTL Mode. With F5, F100, F80, series Cameras spot metering system is always TTL.
F100	AF lens other than D type	All Modes	All Modes	Multi-Sensor BL	
F90X/N90ser. F80/N80ser. F70D/N70	Without Built-in CPU	A/M Modes	Center-weighted, Spot Metering	Center Weighted / Spot Fill-Flash	
F4 Series F-801S/N8008S F-801/N8008 F65/N65 Pronea 600i	With Built-in CPU	All Modes	Matrix Pattern Center-weighted, Spot Metering	TTL BL Center Weighted / Spot Fill-Flash	Can switch to TTL Mode. TTL BL can work with only F4 series, AF F3, Ai-S, Ai, Series E lens. Spot metering system of F4 is always TTL. Pronea 600i will be TTL, when exposure mode is "M". Center Weighted BL cannot work.
	Without Built-in CPU	A/M Modes	Center-weighted, Spot Metering	Center Weighted / Spot Fill-Flash	
F601/N6006 F-601M	With Built-in CPU	All Modes	Matrix Pattern Center-weighted, Spot Metering	TTL BL Center Weighted / Spot Fill-Flash	Spot Metering cannot use with F-601M
	Without Built-in CPU	A/M Modes	Center-weighted, Spot Metering	Center Weighted / Spot Fill-Flash	
F60D/N60 F50D/N50 F-401X/4004S	With Built-in CPU	P/S A/M		TTL BL	If exposure mode is "M", it will be Center Weighted / Spot Fill-Flash
	Without Built-in CPU	M		Center Weighted / Spot Fill-Flash	
F501/N2020 F301/N2000	Built-in CPU lens, Ai-S, Ai, Series E, AF F3 Lens Except above lenses	P A/M A/M		TTL Programmed TTL TTL	
F401S/N4004S F401/N4004	With Built-in CPU	P/S A/M		TTL Programmed TTL	
FA, FE2 FG, F3, FM3	Without Built-in CPU; Without Built-in CPU	M A/M		TTL	

1. Set the exposure mode of the camera. (However, depending on the camera, exposure setting may vary). Please refer to Camera's Instruction manual.
2. Slide the Power Switch to the TTL Position.

■ If the flash coverage angle indicator blinks when you turn on the power of your flash, please make sure that the flash head bounce angle is adjusted to the normal (0°) position.

3. Focus onto the subject.
4. Press the shutter button after the flash is charged.

■ If the Ready Lamp blinks, the flash power is not sufficient for that situation. Please retake the picture at a distance closer to the subject.

■ If you use the AF camera with AF lens, the AF Auxiliary Light will turn on automatically as you focus on a subject in a dark area. However the AF Auxiliary Light will not light up if central focus area is not selected. Note: Effective distance is up to about 0.7 to 9 meter (2.3-29.5 feet).

■ When the flash is fully charged, the flash mark will appear in the finder. If the shutter is released before the flash is fully charged, the camera will take the picture at a slow shutter speed, with no flash.

■ To conserve battery power, the flash unit automatically turns itself off when the flash is not used within approximately 80seconds. To turn the flash on again, depress the "TEST" button or the camera shutter button, halfway.

■ In case of the combination with , on the above chart, the flash coverage angle will be set automatically, according to focal length of the attached lens. In case of attaching the AF zoom lens, the flash coverage angle will be changed according to lens zoom setting.

In case of other combinations, the flash coverage angle will be set to 24mm.

■ Please refer to «chart.1» for the effective distance ranges.

MANUEL FLASH OPERATION

This flash unit can be used in Manual Mode at full power and at 1/16 power.

1. Set the camera's exposure mode to Manual / M mode.
2. Slide the flash unit's Power Switch to MH (full flash power) or to ML (1/16 flash power).
3. Focus on the subject and set the camera's F-stop, using the exposure calculated by the formula shown below:

$$F\text{-stop} = \text{Guide Number (G.N.)} \div \text{Flash to Subject Distance (m)}$$

4. After the flash is fully charged, press the Shutter Release button to take the picture.

Guide Number will change according to the Zoom Head position, (see «chart.2»). Guide Number will also change according to film speed (ISO), (see «chart.3»). In the case of non-ISO100 speed films, multiply the «chart.3» number by the «chart.2» number. For example, using ISO400 film, Zoom Head position for 50mm and the MH mode; multiply the «chart.3» number "2" by the «chart.2» number "40": $40 \times 2 = 80$. This will be the new effective Guide Number (G.N.) in meters. To determine the G.N. in feet, multiply the G.N. in meters by 3.3.

EX. If flash to subject distance is 10 meters:

$$F\text{-stop} = 80 \div 10 = 8 \text{ (8 is the F-stop to set on the camera.)}$$

When repeatedly using the flash in the MH mode, it should be allowed to "rest" for about 15 minutes after each 15 flashes. If used under the same conditions in the ML mode, the flash should be allowed to "rest" after each 40 flashes.

WIDE PANEL

This flash is equipped with built in type wide panel, which can provide ultra wide 17mm angle of coverage. Slide out the wide panel and flip it down to cover flash's head. Then the coverage angle setting of the flash will be set to 17mm automatically (fig. 6).

■ The flash coverage angle indicator will show that the wide panel is in use by blinking the both end values (24mm and 105mm) slowly (1sec each time).

■ If the built-in wide panel comes off accidentally, adjustment mechanism of flash coverage angle will not function. In this case please contact the store where you have purchased the flash, or a service station.

BOUNCE FLASH

When you take a photo with flash in a room, sometimes a strong shadow will appear behind the subject, if you point the flash head upwards or sideways to reflect the light off the ceiling, wall etc. the subject will be illuminated softly. Press the lock button and adjust the flash head to set the bounce angle.

UP: 0°, 60°, 75°, 90° DOWN: 0°, 7°

RIGHT: 0°, 60°, 75°, 90° LEFT: 0°, 60°, 75°, 90°, 120°, 150°, 180° (fig. 7)

■ The picture will receive the color from the reflecting surface. Please choose a white surface for bouncing.

Close-up Exposures

For bounce flash can be tilted 7° downward for close-ups. The Flash will be effective only for the subjects 0.5 meter to 2 meters.

■ The Flash coverage angle display will blink (2 times / second), when you set the flash head tilted downward by 7°.

SPECIFICATIONS

TYPE: Clip-on type serial-controlled TTL auto zoom electric flash

GUIDE NUMBER: 53(ISO 100/m, 105mm head position)

POWER SOURCE: Four AA type alkaline batteries or, Four AA type Ni-Cd batteries or, Four AA type Ni-MH Nickel-Metal Hydride

RECYCLING TIME :about 6.0sec. (Alkaline batteries) :about 4.0 sec. (Ni-Cd, Ni-MH Nickel-Metal Hydride)

NUMBER OF FLASHES: about 220 flashes (Alkaline batteries) : about 100 flashes (Ni-Cd, Ni-MH Nickel-Metal Hydride)

FLASH DURATION: about 1 / 700 sec. (full power firing) AUTO POWER OFF: Available

FLASH ILLUMINATE ANGLE: 24mm-105mm motor powered control (17mm with Built-in Wide Panel)

WEIGHT : 320 g/11.3oz. DIMENSIONS : 77mm(W)/3.0in. x 139mm(H)/5.5in. x 117mm(L)/4.6in.