

SIGMA**ELECTRONIC FLASH
EF-530 DG ST SA-STTL**

使用説明書	ISTRUZIONI PER L'USO
INSTRUCTIONS	BRUGSANVISNING
BEDIENUNGSANLEITUNG	用戶手冊
MODE D'EMPLOI	사용자 설명서
GEBRUIKSAANWIJZING	РУКОВОДСТВО ПО ЭКСПЛУАТАЦИИ
INSTRUCCIONES	

SIGMA CORPORATION

2-4-16 Kuriki, Asao-ku, Kawasaki-shi, Kanagawa 215-8530 Japan

Phone : 044 - 989 - 7430 Fax : 044 - 989 - 7451

株式会社シグマ

本 社 〒215-8530 神奈川県川崎市麻生区栗木 2 丁目 4 番 16 号
 ☎(044) 989-7430(代) FAX: (044) 989-7451
 (カスタマーサービス直通) ☎(044) 989-7436

工 場 〒969-3395 福島県耶麻郡磐梯町大字大谷字日知坂 6594
 ☎0242(73)2771(代)

札幌営業所 〒007-0865 札幌市東区伏古 5 条 4 丁目 1 番 9 号 伏古ビル 2F
 ☎011(786)3710

大阪営業所 〒541-0059 大阪市中央区博労町 1-7-2 堺筋トラストビル 8F
 ☎06(6271)1548

福岡営業所 〒812-0013 福岡市博多区博多駅東 1-11-15 博多駅東口ビル 6F
 ☎092(475)5635

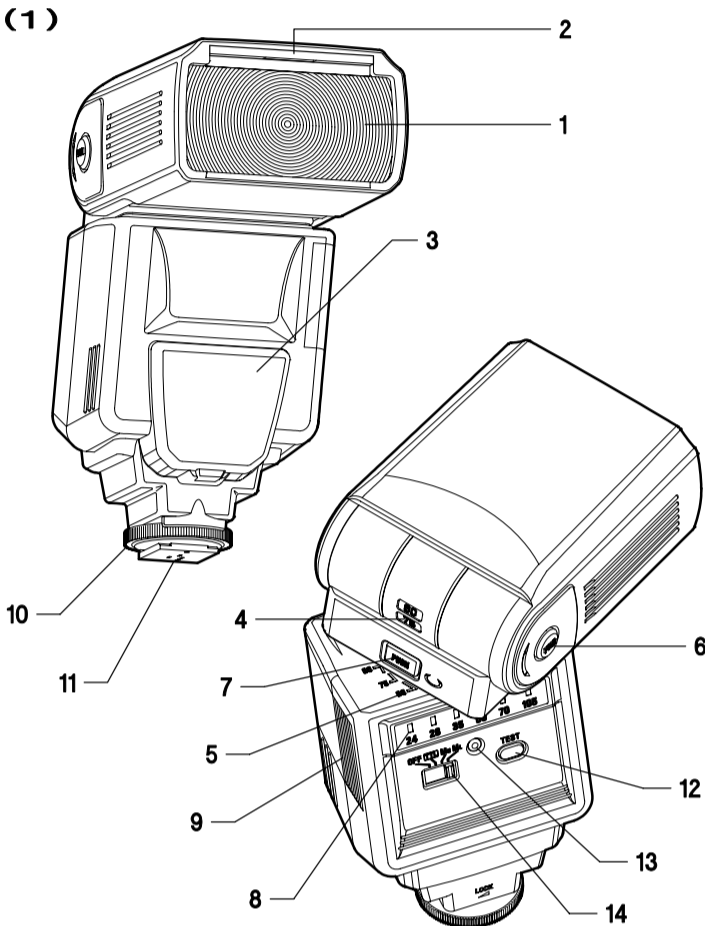
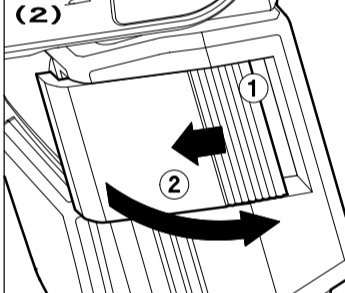
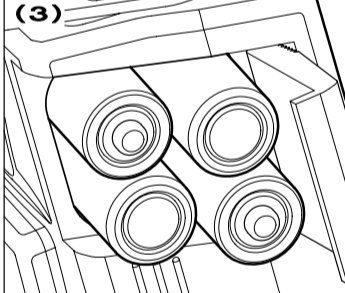
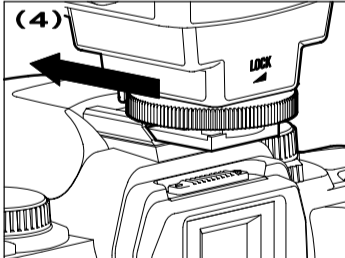
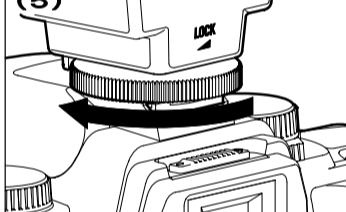
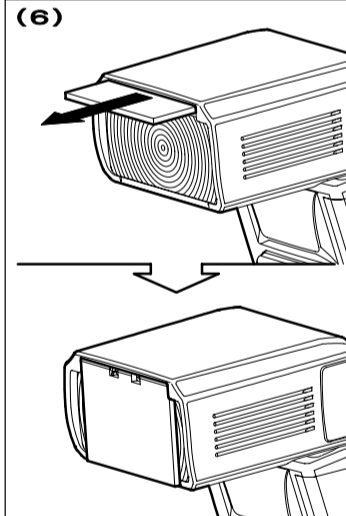
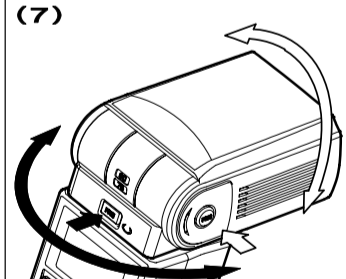
インターネットホームページアドレス <http://www.sigma-photo.co.jp>**(1)****(2)****(3)****(4)****(5)****(6)****(7)**

《表1》《chart.1》《Tabelle 1》《Tableau 1》《tabel 1》《Tabla 1》

	m						
	ft						
	17mm	24mm	28mm	35mm	50mm	70mm	105mm
1.4	1.3-14.3	1.8-20.0	1.9-20.7	2.0-22.1	2.6-28.6	2.9-32.1	3.4-37.9
	4.3-46.9	5.9-65.6	6.2-67.9	6.6-72.5	8.5-93.8	9.5-105.3	11.2-124.3
2.0	0.9-10.0	1.3-14.0	1.3-14.5	1.4-15.5	1.8-20.0	2.0-22.5	2.4-26.5
	3.0-32.8	4.3-45.9	4.3-47.6	4.6-50.9	5.9-65.6	6.6-73.8	7.9-86.9
2.8	0.7-7.1	0.9-10.0	0.9-10.4	1.0-11.1	1.3-14.3	1.5-16.1	1.7-18.9
	2.3-23.3	3.0-32.8	3.0-34.1	3.3-36.4	4.3-46.9	4.9-52.8	5.6-62.0
4.0	0.7-5.0	0.7-7.0	0.7-7.3	0.7-7.8	0.9-10.0	1.0-11.3	1.2-13.3
	2.3-16.4	2.3-23.0	2.3-24.0	2.3-25.6	3.0-32.8	3.3-37.1	3.9-43.6
5.6	0.7-3.6	0.7-5.0	0.7-5.2	0.7-5.5	0.7-7.1	0.7-8.0	0.9-9.5
	2.3-11.8	2.3-16.4	2.3-17.1	2.3-18.0	2.3-23.3	2.3-26.2	3.0-31.2
8.0	0.7-2.5	0.7-3.5	0.7-3.6	0.7-3.9	0.7-5.0	0.7-5.6	0.7-6.6
	2.3-8.2	2.3-11.5	2.3-11.8	2.3-12.8	2.3-16.4	2.3-18.4	2.3-21.7
11.0	0.7-1.8	0.7-2.5	0.7-2.6	0.7-2.8	0.7-3.6	0.7-4.1	0.7-4.8
	2.3-5.9	2.3-8.2	2.3-8.5	2.3-9.2	2.3-11.8	2.3-13.5	2.3-15.7
16.0	0.7-1.3	0.7-1.8	0.7-1.8	0.7-1.9	0.7-2.5	0.7-2.8	0.7-3.3
	2.3-4.3	2.3-5.9	2.3-5.9	2.3-6.2	2.3-8.2	2.3-9.2	2.3-10.8
22.0	0.7-0.9	0.7-1.3	0.7-1.3	0.7-1.4	0.7-1.8	0.7-2.0	0.7-2.4
	2.3-3.0	2.3-4.3	2.3-4.3	2.3-4.6	2.3-5.9	2.3-6.6	2.3-7.9
32.0		0.7-0.9	0.7-0.9	0.7-1.0	0.7-1.3	0.7-1.4	0.7-1.7
		2.3-3.0	2.3-3.0	2.3-3.3	2.3-4.3	2.3-4.6	2.3-5.6

《表2》《chart.2》《Tabelle 2》《Tableau 2》《tabel 2》《Tabla 2》



	17mm	24mm	28mm	35mm	50mm	70mm	105mm
MH	20.0	28.0	29.0	31.0	40.0	45.0	53.0
ML	5.0	7.0	7.3	7.8	10.0	11.3	13.3

《表3》《chart.3》《Tabelle 3》《Tableau 3》《tabel 3》《Tabla 3》





ISO25	ISO50	ISO200	ISO400	ISO800	ISO1600	ISO3200
20.0	28.0	29.0	31.0	40.0	45.0	53.0

ENGLISH







Thank you very much for purchasing the Sigma EF-530 ST SA-STTL Electronic Flash. This product is specifically developed for the SIGMA SA / SD series SLR cameras. Depending on the camera model, functions and operation may vary. Please read this instruction booklet carefully. To add to your enjoyment of photography, the flash has a variety of features. To make the most of all these features, and to get the maximum performance and enjoyment from your flash, please read this instruction booklet, together with your camera's instruction manual, before using the flash, and also keep it handy for your future reference.

PRECAUTIONS  Symbol denotes the important points, where warning and caution are required.
 Symbol contains information regarding the actions that must be avoided.

Warning !!
Using the product disregarding this warning sign might cause serious injury or other dangerous results.

-  This flash contains high voltage circuits. To avoid electric shock or burns, do not attempt to disassemble the flash. If the outside shell of the unit is broken or cracked, do not touch the mechanism inside.
-  Do not fire the flash close to eyes. Otherwise the bright light could damage the eyes. Keep at least 1m/3feet distance between face and the flash unit, when taking a picture with flash.
-  Do not touch the synchro terminal of your camera when the flash is attached to hot shoe. High voltage circuitry could cause electric shock.
-  Never use your camera in an environment where flammable, burnable, gas, liquids or chemicals, etc. exist. Otherwise, it might cause fire or explosion.

Caution!!
Using the product disregarding this caution sign might cause injury or damage.

-  Do not use this flash unit on any camera other than the SIGMA SA / SD series cameras; otherwise the flash may damage the circuitry of these cameras.
-  This flash unit is not waterproof. When using the flash and camera in the rain or snow or near water, keep it from getting wet. It is often impractical to repair internal electrical components damaged by water.
-  Never subject the flash and camera to shock, dust, high temperature or humidity. These factors might cause fire or malfunctioning of your equipment.
-  When the flash is subjected to sudden temperature change, as when the flash unit is brought from a cold exterior to warm interior, condensation might form inside. In such a case, place your equipment in a sealed plastic bag before such a change, and do not use the flash unit, until it reaches room temperature.
-  Do not store your flash in a drawer or cupboard etc., containing naphthalene, camphor or other insecticides. These chemicals will have negative effects on the flash unit.
-  Do not use a thinner, Benzene or other cleaning agents to remove dirt or finger prints from the component. Clean with a soft, moistened cloth.
-  For extended storage, choose a cool dry place, preferably with good ventilation. It is recommended that the flash be charged and fired several times a month, to maintain proper capacitor functioning.

DESCRIPTION OF THE PARTS (fig.1)

- 1.Flash Head 2.Built-in Wide Panel 3.AF Auxiliary Light 4.Bounce Angle; Up and Down
- 5.Bounce Angle; Right and Left 6.Bounce Lock and Release Button; Up and Down
- 7.Swivel Lock and Release Button; Right and Left 8.flash coverage angle indicator
- 9.Battery Cover 10.Shoe Ring 11.Shoe 12.TEST Button 13.Ready Light 14.Power Switch

ABOUT THE BATTERY

This flash unit uses four "AA" type Alkaline dry cell batteries or Ni-Cad, Ni-MH, rechargeable batteries. Manganese batteries can also be used but as they have a shorter life than Alkaline batteries, we do not recommend using them. Please replace batteries if it takes more than 30seconds to light the Ready Lamp.

- To assure proper electrical contact, clean the battery terminals before installing the batteries
- NiCad batteries do not have standardized contacts. If you use NiCad batteries, please confirm that the battery contacts touch the battery compartment properly.
- To prevent battery explosion, leakage or overheating, use four new AA batteries of the same type and brand. Do not mix the type or new and used batteries.
- Do not disassemble or short-circuit batteries, or expose them fire or water; they may explode. Also, do not recharge the batteries other than Ni-Cd rechargeable batteries.
- When the flash will not be used for an extended period of time, remove the batteries from the flash, to avoid the possibility of damage from leakage.
- Battery performance decreases at low temperatures. Keep batteries insulated when using the flash in cold weather.
- As with any flash, it is recommended you carry spare batteries when on a long trip, or when photographing outdoors in cold weather.

BATTERY LOADING

1. Be sure to set the Power Switch to the off position then slide, the battery cover in the direction of the arrow to open (fig.2).
2. Insert four AA size batteries into the battery chamber. Be sure the + and - ends of the batteries are aligned according to the diagram in the chamber (fig.3).
3. Close the cover.
4. Slide the Power Switch to the ON position. After few seconds, the Ready Lamp will light, indicating that the flash unit can be fired.
5. Please press the "Test Button" to be sure that the flash is working properly.

- If the battery power is not sufficient, or if there is an electronic information error, the flash coverage angle indicator will blink to indicate the condition.

ATTACHING AND REMOVING THE FLASH TO AND FROM THE CAMERA

Be sure turn off the Power Switch. Then insert the Shoe Base into the hot shoe on the camera and turn the Shoe Locking Ring until it is tight (fig.4)(fig.5).

- When you attach or remove the flash, grasp the bottom of the flash to prevent damage to the shoe foot and camera's hot shoe.
- If the camera's built-in flash is set in up position, please close it before you attach the flash unit.
- To remove the flash, rotate the shoe-locking ring in the opposite direction of ◀LOCK mark, until it stops.

TTL AUTO FLASH

In the TTL AUTO Mode, the camera will control the amount of flash lighting to get the appropriate exposure for the subject.

1. Set the camera's exposure mode to **P** Mode. (In the case of SA-300, SA-300N and SA-5 set to "★" fully automatic mode)
2. Slide the Power Switch to the TTL Position.
 - If the flash coverage angle indicator blinks when you turn on the power of your flash, please make sure that the flash head bounce angle is adjusted to the normal (0°) position.
3. Focus onto the subject.
4. Press the shutter button after the flash is charged.
 - After a picture is taken, and the film receives appropriate exposure, the Ready Lamp will blink. If the Ready Lamp does not blink, it indicates that the flash light was not sufficient for that particular situation. Please retake the picture at a distance closer to the subject.
 - The AF Auxiliary Light will turn on automatically as you focus on a dark area. Note: Effective distance is up to about 0.7 to 9 meter (2.3-29.5 feet).
 - When the flash is fully charged, the flash mark will appear in the finder. If the shutter is released before the flash is fully charged, the camera will take the picture at a slow shutter speed, with no flash.
 - To conserve battery power, the flash unit automatically turns itself off when the flash is not used within approximately 300 seconds. To turn the flash on again, depress the "TEST" button or the camera shutter button, halfway.
 - The flash will automatically set the Zoom Head position according to the focal length of your lens.
 - Please refer to «chart.1» for the effective distance ranges.

USING FLASH IN OTHER CAMERA MODES

Shutter Speed Priority Setting

By selecting the **S** mode of the camera, you can set the shutter speed from 30sec. to 1/X sync speed. When you set the desired shutter speed, the camera will select the appropriate aperture value for the background. If the subject is too light or too dark, the aperture value indicator will blink and show the limit values (maximum or minimum aperture). In such as case, the camera proceeds to take flash photograph at the limit value. Thus, the main subject in the picture may be exposed correctly, but the background will become under or over exposed.

Aperture Priority Setting

By selecting the **A** mode of your camera, the camera will select the appropriate shutter speed for the background. If the subject is too bright or too dark, the shutter speed indicator will blink and show the limit highest or slowest shutter speed value. The highest shutter speed will be limited to the camera's normal flash synchronization speed. In such a case, the camera proceeds to take a flash photograph at the limit value. Thus, the main subject in a picture may be exposed correctly, but the background will become under or overexposed.

When used with M Mode

You can set the desired shutter speed and aperture value. The sync speed of camera is 30sec. If you adjust exposure according to the exposure meter indication, the camera will work as for Daylight synchronization flash or slow synchronization.

MANUEL FLASH OPERATION

This flash unit can be used in Manual Mode at full power and at 1/16 power.

1. Set the camera's exposure mode to Manual / M mode.
2. Slide the flash unit's Power Switch to MH (full flash power) or to ML (1/16 flash power).
3. Focus on the subject and set the camera's F-stop, using the exposure calculated by the formula shown below:
F-stop = Guide Number (G.N.) ÷ Flash to Subject Distance (m)
4. After the flash is fully charged, press the Shutter Release button to take the picture.

Guide Number will change according to the Zoom Head position, (see «chart.2»). Guide Number will also change according to film speed (ISO),(see «chart.3»). For example, using ISO400 film, Zoom Head position for 50mm and the MH mode; multiply the «chart.3» number "2" by the «chart.2» number "40": 40×2=80. This will be the new effective Guide Number (G.N.) in meters. To determine the G.N. in feet, multiply the G.N. in meters by 3.3.

EX. If flash to subject distance is 10 meters:

$$F\text{-stop} = 80 \div 10 = 8 \text{ (8 is the F-stop to set on the camera.)}$$

When repeatedly using the flash rapidly in the MH mode, it should be allowed to "rest" for about 15 minutes after each 15 flashes. If used under the same conditions in the ML mode, the flash should be allowed to "rest" after each 40 flashes.

WIDE PANEL

This flash is equipped with built in type wide panel, which can provide ultra wide 17mm angle of coverage. Slide out the wide panel and flip it down to cover flash's head. Then the coverage angle setting of the flash will be set to 17mm automatically (fig. 6).

- The flash coverage angle indicator will show that the wide panel is in use by blinking the both end values (24mm and 105mm) slowly (1sec each time).
- If the built-in wide panel comes off accidentally, adjustment mechanism of flash coverage angle will not function. In this case please contact the store where you have purchased the flash, or a service station.

BOUNCE FLASH

When you take a photo with flash in a room, sometimes a strong shadow will appear behind the subject, if you point the flash head upwards or sideways to reflect the light off the ceiling, wall etc. the subject will be illuminated softly. Press the lock button and adjust the flash head to set the bounce angle.

UP: 0°, 60°, 75°, 90° DOWN: 0°, 7°

RIGHT: 0°, 60°, 75°, 90° LEFT: 0°, 60°, 75°, 90°, 120°, 150°, 180° (fig. 7)

- The picture will receive the color from the reflecting surface. Please choose a white surface for bouncing.

Close-up Exposures

For bounce flash can be tilted 7° downward for close-ups. The Flash will be effective only for the subjects 0.5 meter to 2 meters.

- The Flash coverage angle display will blink (2 times / second), when you set the flash head tilted downward by 7°

SPECIFICATIONS

TYPE: Clip-on type serial-controlled TTL auto zoom electric flash

GUIDE NUMBER: 53(ISO 100/m, 105mm head position)

POWER SOURCE: Four AA type alkaline batteries or, Four AA type Ni-Cd batteries or, Four AA type Ni-MH Nickel-Metal Hydride

RECYCLING TIME: about 6.0sec. (Alkaline batteries) : about 4.0 sec. (Ni-Cd, Ni-MH Nickel-Metal Hydride)

NUMBER OF FLASHES: about 220 flashes (Alkaline batteries) : about 100 flashes (Ni-Cd, Ni-MH Nickel-Metal Hydride)

FLASH DURATION: about 1 / 700 sec. (full power firing)

FLASH ILLUMINATE ANGLE: 24mm-105mm motor powered control (17mm with Built-in Wide Panel)

AUTO POWER OFF: Available

WEIGHT: 305g/110.8oz.

DIMENSIONS : 77mm(W)/3.0in. x 139mm(H)/5.5in. x 117mm(L)/4.6in.